

SCHEMAT SYSTEMU SCHEME OF THE SYSTEM

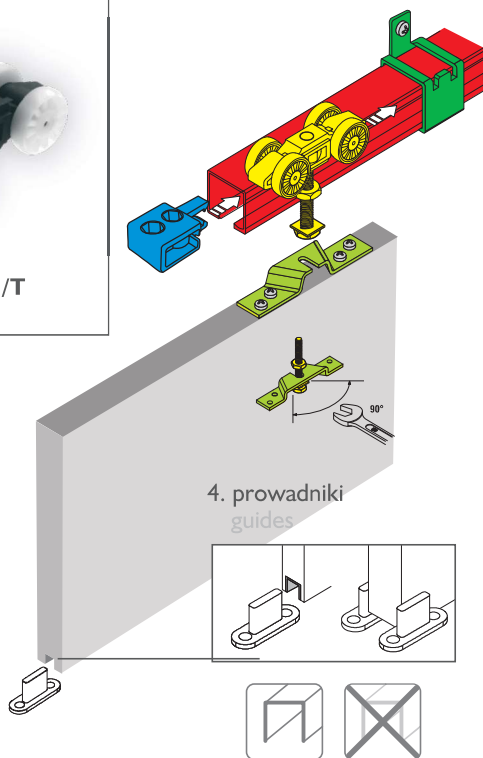

1. uchwyty do szyny rail fastenings

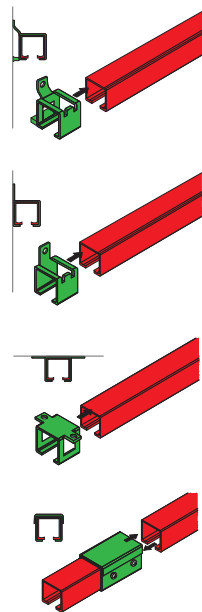

2. mocowanie maskownicy aluminiowej anodowanej assembling of anodized aluminum cover

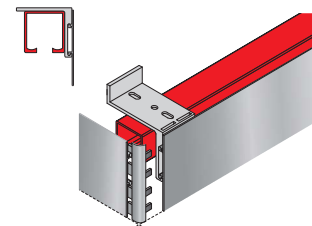

3. mocowanie maskownicy drewnianej assembling of wooden cover

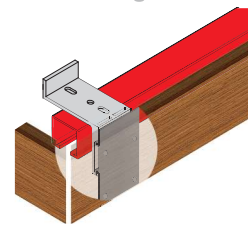

5. mocowanie boczne side assembling

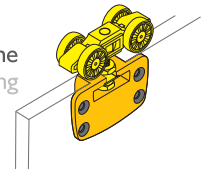

SZYNY I PROFILE RAILS AND PROFILES

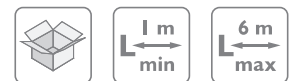

nazwa name	szyna górna K-075 upper rail K-075	maskownica do K-075 cover for K-075	ceownik C-10 c-profile
numer number	11000000	11190000	16000000
materiał material	AI NATURAL	AI ANODIZED	AI NATURAL
rysunek drawing			

ELEMENTY MASKOWNICY COVER PARTS



nazwa name	uchyt sufitowy fastening for ceiling	uchyt ścienny fastening for wall	narożnik RT8 corner RT8	mocowanie maskownicy drewnianej fastening for wooden cover
numer number	11191000	11192000	11193000	11193100
materiał material	ABS PC	ABS PC	ABS PC	AI ANODIZED
rysunek drawing				



KOMPLET OKUĆ

HARDWARE SET



nazwa name	okucie MP-075/T hardware MP-075/T	mocowanie do płyty PB-075 fastening to board PB-075	stoper KPZ-075 stopper KPZ-075	biały prowadnik AO-075 white guide AO-075
numer number	11178000	11121000	11141000	11150000
materiał material	ABS PC	STEEL ZINC	ABS PC	ABS PC
rysunek drawing				
1 11061000	2	2	2	2
2 11062000	4	4	2	4

ARTYKUŁY POJEDYNCZE

SINGLE ARTICLES



nazwa name	uchwyt do ściany z wkrętem dociskowym SKU-M5 rail holder to wall with screw SKU-M5	uchwyt do ściany SKU-075 rail holder to wall SKU-075	uchwyt do sufitu KK-075 rail holder to ceiling KK-075	uchwyt dystansowy do ściany z wkrętem dociskowym SKL-M5 rail holder to wall with distance and screw SKL-M5	uchwyt dystansowy do ściany SKL-075 rail holder to wall with distance SKL-075	łącznik szyn (K-075 oraz K-076) LKU-075 rails (K-075 and K-076) connector LKU-075
numer number	11136000	11131000	11132000	11135000	11134000	11133000
rysunek drawing						

ARTYKUŁY ZAMIENNE

REPLACEMENT ARTICLES



nazwa name	mocowanie boczne PBB-075 side fastening PBB-075	brązowy prowadnik AO-075 brown guide AO-075	czarny prowadnik AO-075 black guide AO-075
numer number	11180000	11151000	11147000
materiał material	ZNAL	ABS PC	ABS PC
rysunek drawing			

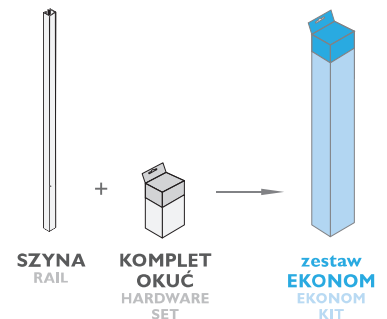

**INFORMACJA O ELEMENTACH
OPCJONALNYCH NA STRONIE 33**
INFORMATION ABOUT OPTIONAL
ELEMENTS ON THE PAGE 33